

NSS60601MZ4

60 V, 6.0 A, Low $V_{CE(sat)}$ NPN Transistor

ON Semiconductor's e²PowerEdge family of low $V_{CE(sat)}$ transistors are surface mount devices featuring ultra low saturation voltage ($V_{CE(sat)}$) and high current gain capability. These are designed for use in low voltage, high speed switching applications where affordable efficient energy control is important.

Typical applications are DC-DC converters and power management in portable and battery powered products such as cellular and cordless phones, PDAs, computers, printers, digital cameras and MP3 players. Other applications are low voltage motor controls in mass storage products such as disc drives and tape drives. In the automotive industry they can be used in air bag deployment and in the instrument cluster. The high current gain allows e²PowerEdge devices to be driven directly from PMU's control outputs, and the Linear Gain (Beta) makes them ideal components in analog amplifiers.

Features

- This is a Pb-Free Device

MAXIMUM RATINGS ($T_A = 25^\circ\text{C}$)

Rating	Symbol	Max	Unit
Collector-Emitter Voltage	V_{CEO}	60	Vdc
Collector-Base Voltage	V_{CBO}	100	Vdc
Emitter-Base Voltage	V_{EBO}	6.0	Vdc
Collector Current – Continuous	I_C	6.0	A
Collector Current – Peak	I_{CM}	12.0	A

THERMAL CHARACTERISTICS

Characteristic	Symbol	Max	Unit
Total Device Dissipation $T_A = 25^\circ\text{C}$ Derate above 25°C	P_D (Note 1)	800	mW
		6.5	mW/ $^\circ\text{C}$
Thermal Resistance, Junction-to-Ambient	$R_{\theta JA}$ (Note 1)	155	$^\circ\text{C}/\text{W}$
Total Device Dissipation $T_A = 25^\circ\text{C}$ Derate above 25°C	P_D (Note 2)	2	W
		15.6	mW/ $^\circ\text{C}$
Thermal Resistance, Junction-to-Ambient	$R_{\theta JA}$ (Note 2)	64	$^\circ\text{C}/\text{W}$
Total Device Dissipation (Single Pulse < 10 sec.)	$P_{D\text{single}}$ (Note 3)	710	mW
Junction and Storage Temperature Range	T_J, T_{stg}	-55 to +150	$^\circ\text{C}$

Stresses exceeding Maximum Ratings may damage the device. Maximum Ratings are stress ratings only. Functional operation above the Recommended Operating Conditions is not implied. Extended exposure to stresses above the Recommended Operating Conditions may affect device reliability.

1. FR-4 @ 7.6 mm², 1 oz. copper traces.
2. FR-4 @ 645 mm², 1 oz. copper traces.
3. Thermal response.



ON Semiconductor®

<http://onsemi.com>

**60 VOLTS, 6.0 AMPS
2.0 WATTS
NPN LOW $V_{CE(sat)}$ TRANSISTOR
EQUIVALENT $R_{DS(on)} 50 \text{ m}\Omega$**

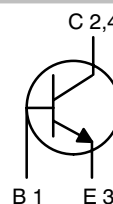

Schematic

MARKING DIAGRAM



SOT-223
CASE 318E
STYLE 1

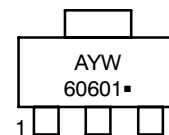

- A = Assembly Location
- Y = Year
- W = Work Week
- 60601 = Specific Device Code
- = Pb-Free Package

PIN ASSIGNMENT

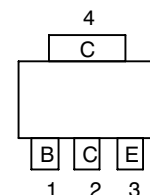

Top View Pinout

ORDERING INFORMATION

Device	Package	Shipping†
NSS60601MZ4T1G	SOT-223 (Pb-Free)	1000/ Tape & Reel
NSS60601MZ4T3G	SOT-223 (Pb-Free)	4000/ Tape & Reel

†For information on tape and reel specifications, including part orientation and tape sizes, please refer to our Tape and Reel Packaging Specification Brochure, BRD8011/D.

NSS60601MZ4

ELECTRICAL CHARACTERISTICS (T_A = 25°C unless otherwise noted)

Characteristic	Symbol	Min	Typ	Max	Unit
OFF CHARACTERISTICS					
Collector - Emitter Breakdown Voltage (I _C = 10 mA, I _B = 0)	V _{(BR)CEO}	60			Vdc
Collector - Base Breakdown Voltage (I _C = 0.1 mA, I _E = 0)	V _{(BR)CBO}	100			Vdc
Emitter - Base Breakdown Voltage (I _E = 0.1 mA, I _C = 0)	V _{(BR)EBO}	6.0			Vdc
Collector Cutoff Current (V _{CB} = 40 Vdc, I _E = 0)	I _{CBO}			0.1	μAdc
Emitter Cutoff Current (V _{EB} = 6.0 Vdc)	I _{EBO}			0.1	μAdc

ON CHARACTERISTICS

DC Current Gain (Note 4) (I _C = 500 mA, V _{CE} = 2.0 V) (I _C = 1.0 A, V _{CE} = 2.0 V) (I _C = 2.0 A, V _{CE} = 2.0 V) (I _C = 6.0 A, V _{CE} = 2.0 V)	h _{FE}	150 120 100 50		360	
Collector - Emitter Saturation Voltage (Note 4) (I _C = 0.1 A, I _B = 2.0 mA) (I _C = 1.0 A, I _B = 0.100 A) (I _C = 2.0 A, I _B = 0.200 A) (I _C = 3.0 A, I _B = 60 mA) (I _C = 6.0 A, I _B = 0.6 A)	V _{CE(sat)}		0.045 0.085	0.040 0.060 0.100 0.220 0.300	V
Base - Emitter Saturation Voltage (Note 4) (I _C = 1.0 A, I _B = 0.1 A)	V _{BE(sat)}			0.900	V
Base - Emitter Turn-on Voltage (Note 4) (I _C = 1.0 A, V _{CE} = 2.0 V)	V _{BE(on)}			0.900	V
Cutoff Frequency (I _C = 500 mA, V _{CE} = 10 V, f = 100 MHz)	f _T	100			MHz
Input Capacitance (V _{EB} = 5.0 V, f = 1.0 MHz)	C _{ibo}		400		pF
Output Capacitance (V _{CB} = 10 V, f = 1.0 MHz)	C _{obo}		37		pF

SWITCHING CHARACTERISTICS

Delay (V _{CC} = 30 V, I _C = 750 mA, I _{B1} = 15 mA)	t _d		85		ns
Rise (V _{CC} = 30 V, I _C = 750 mA, I _{B1} = 15 mA)	t _r		115		ns
Storage (V _{CC} = 30 V, I _C = 750 mA, I _{B1} = 15 mA)	t _s		1350		ns
Fall (V _{CC} = 30 V, I _C = 750 mA, I _{B1} = 15 mA)	t _f		125		ns

4. Pulsed Condition: Pulse Width = 300 msec, Duty Cycle ≤ 2%.

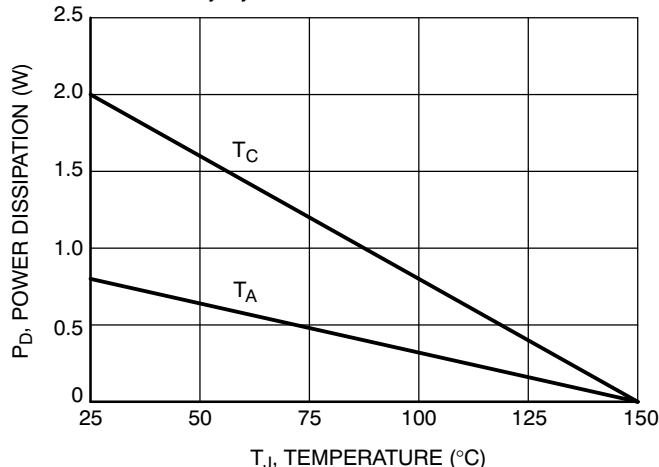

Figure 1. Power Derating

NSS60601MZ4

TYPICAL CHARACTERISTICS

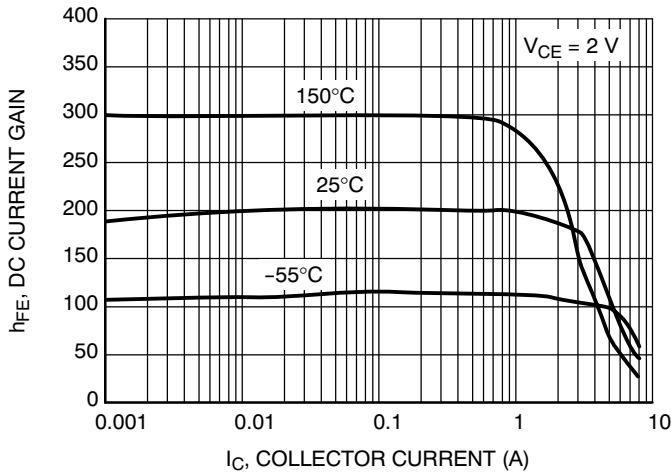

Figure 2. DC Current Gain

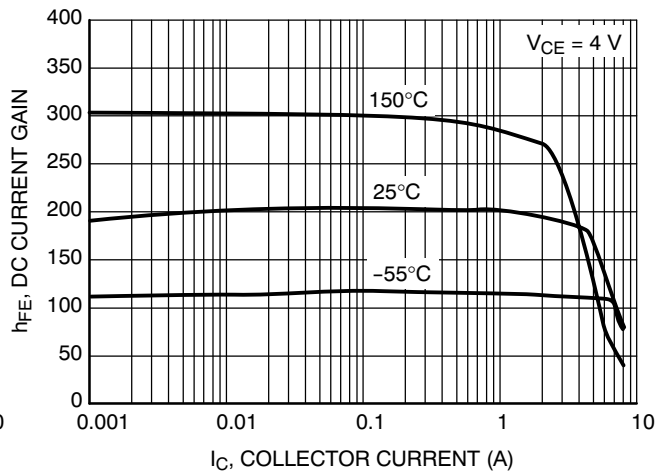

Figure 3. DC Current Gain

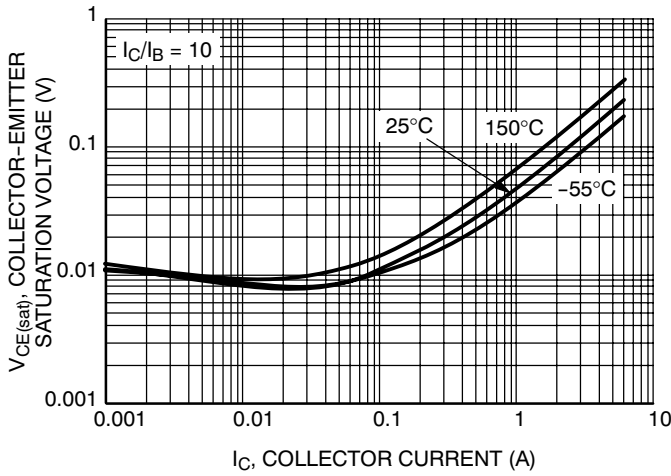

Figure 4. Collector-Emitter Saturation Voltage

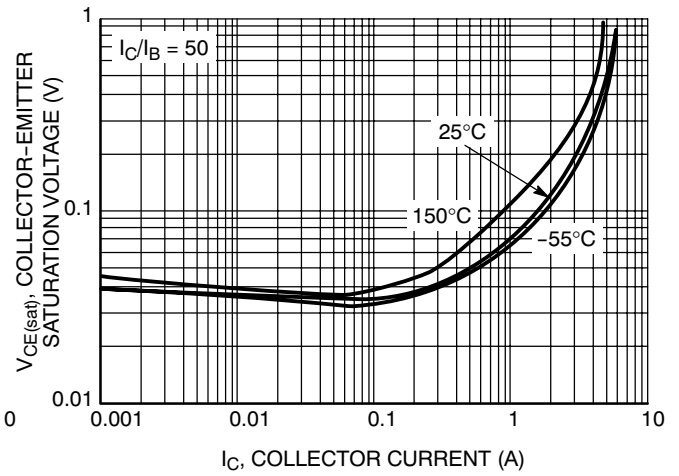

Figure 5. Collector-Emitter Saturation Voltage

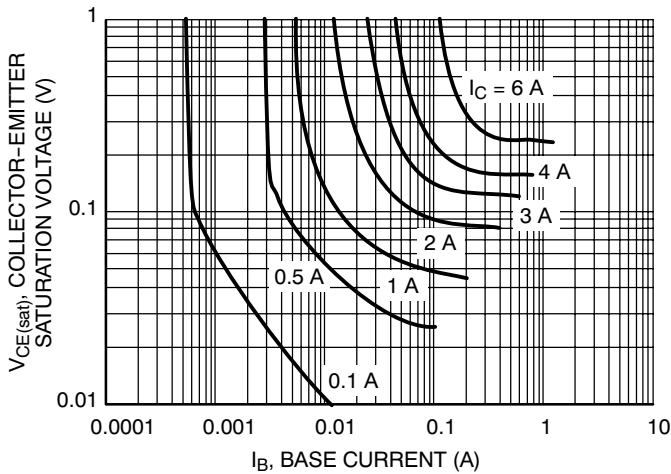

Figure 6. Collector Saturation Region

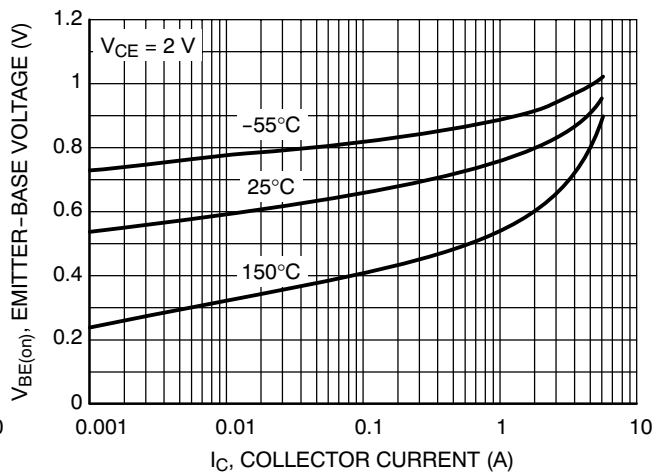

Figure 7. $V_{BE(on)}$ Voltage

NSS60601MZ4

TYPICAL CHARACTERISTICS

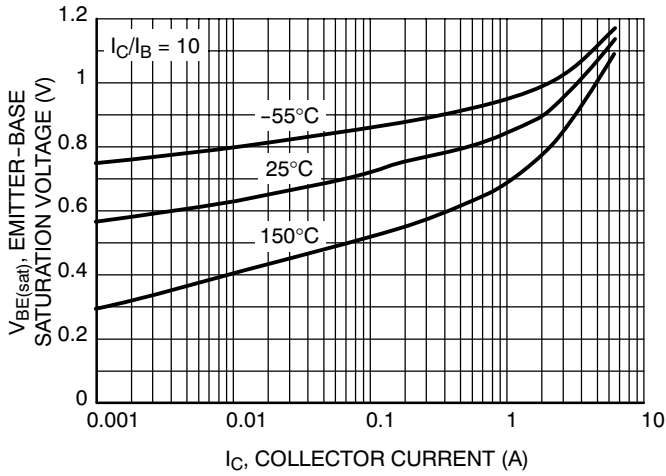

Figure 8. Base-Emitter Saturation Voltage

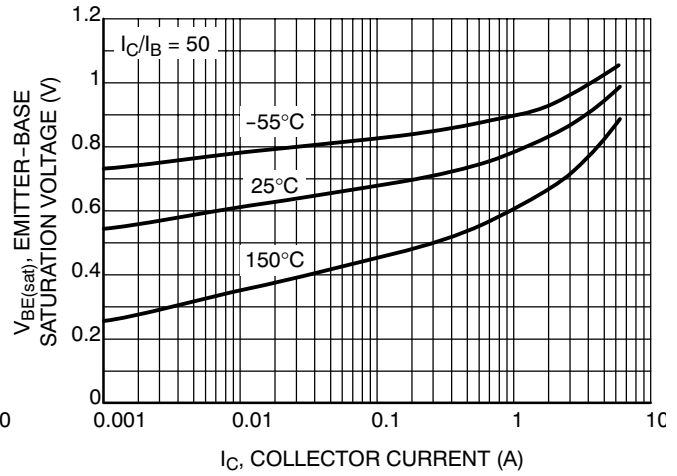

Figure 9. Base-Emitter Saturation Voltage

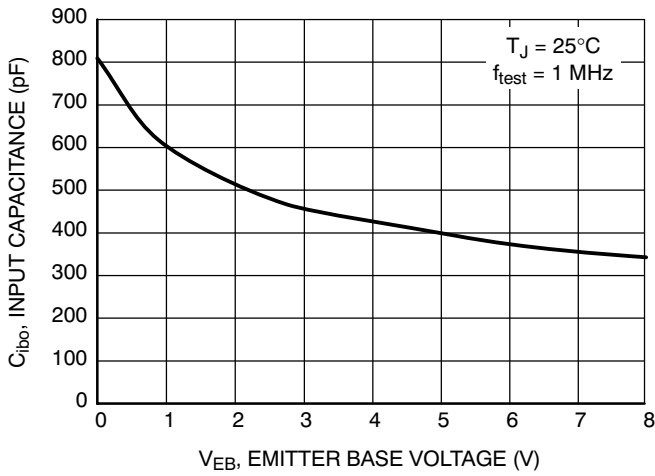

Figure 10. Input Capacitance

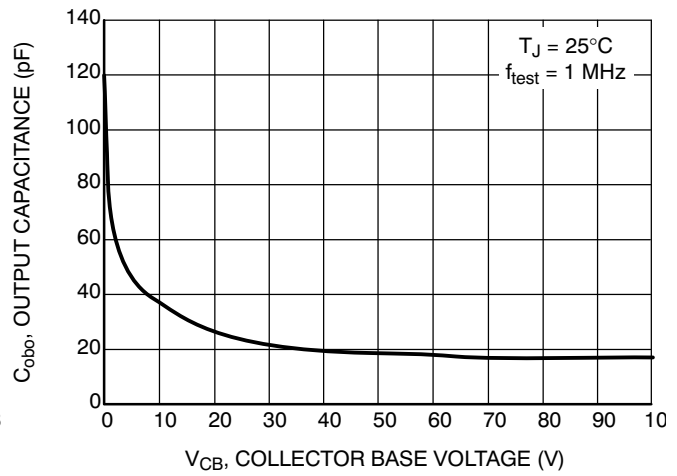

Figure 11. Output Capacitance

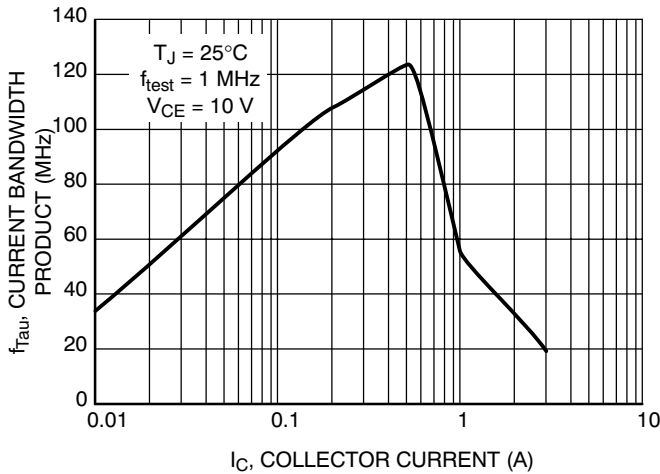

Figure 12. Current-Gain Bandwidth Product

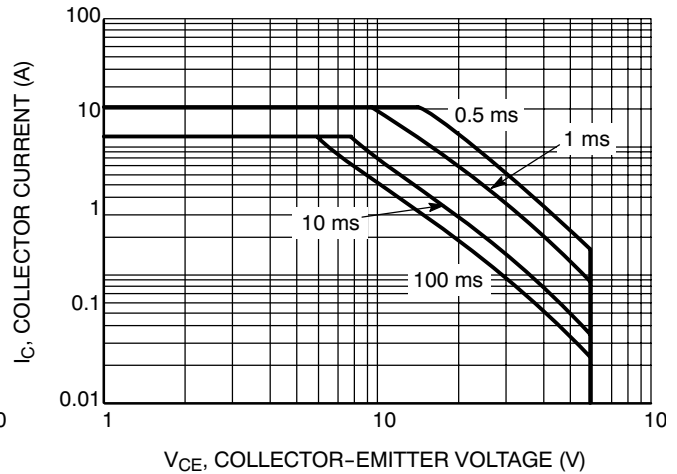
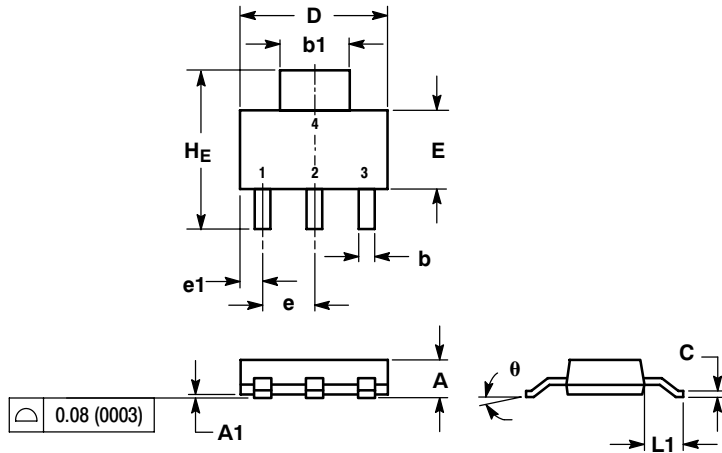

Figure 13. Safe Operating Area

NSS60601MZ4

PACKAGE DIMENSIONS

SOT-223 (TO-261)
CASE 318E-04
ISSUE L



- NOTES:
1. DIMENSIONING AND TOLERANCING PER ANSI Y14.5M, 1982.
2. CONTROLLING DIMENSION: INCH.

DIM	MILLIMETERS			INCHES		
	MIN	NOM	MAX	MIN	NOM	MAX
A	1.50	1.63	1.75	0.060	0.064	0.068
A1	0.02	0.06	0.10	0.001	0.002	0.004
b	0.60	0.75	0.89	0.024	0.030	0.035
b1	2.90	3.06	3.20	0.115	0.121	0.126
c	0.24	0.29	0.35	0.009	0.012	0.014
D	6.30	6.50	6.70	0.249	0.256	0.263
E	3.30	3.50	3.70	0.130	0.138	0.145
e	2.20	2.30	2.40	0.087	0.091	0.094
e1	0.85	0.94	1.05	0.033	0.037	0.041
L1	1.50	1.75	2.00	0.060	0.069	0.078
HE	6.70	7.00	7.30	0.264	0.276	0.287
θ	0°	-	10°	0°	-	10°

- STYLE 1:
PIN 1. BASE
2. COLLECTOR
3. EMITTER
4. COLLECTOR

SOLDERING FOOTPRINT

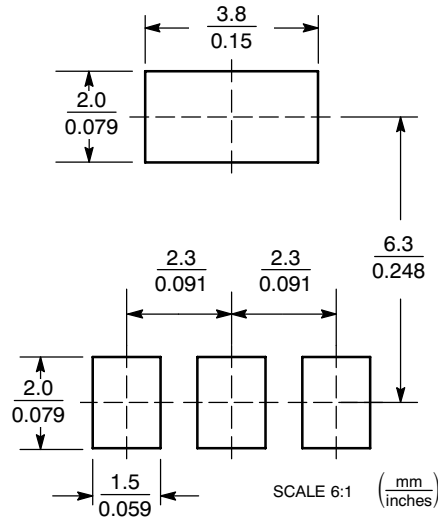

ON Semiconductor and are registered trademarks of Semiconductor Components Industries, LLC (SCILLC). SCILLC reserves the right to make changes without further notice to any products herein. SCILLC makes no warranty, representation or guarantee regarding the suitability of its products for any particular purpose, nor does SCILLC assume any liability arising out of the application or use of any product or circuit, and specifically disclaims any and all liability, including without limitation special, consequential or incidental damages. "Typical" parameters which may be provided in SCILLC data sheets and/or specifications can and do vary in different applications and actual performance may vary over time. All operating parameters, including "Typicals" must be validated for each customer application by customer's technical experts. SCILLC does not convey any license under its patent rights nor the rights of others. SCILLC products are not designed, intended, or authorized for use as components in systems intended for surgical implant into the body, or other applications intended to support or sustain life, or for any other application in which the failure of the SCILLC product could create a situation where personal injury or death may occur. Should Buyer purchase or use SCILLC products for any such unintended or unauthorized application, Buyer shall indemnify and hold SCILLC and its officers, employees, subsidiaries, affiliates, and distributors harmless against all claims, costs, damages, and expenses, and reasonable attorney fees arising out of, directly or indirectly, any claim of personal injury or death associated with such unintended or unauthorized use, even if such claim alleges that SCILLC was negligent regarding the design or manufacture of the part. SCILLC is an Equal Opportunity/Affirmative Action Employer. This literature is subject to all applicable copyright laws and is not for resale in any manner.

PUBLICATION ORDERING INFORMATION

LITERATURE FULFILLMENT:
Literature Distribution Center for ON Semiconductor
RD, Box 5163, Denver, Colorado 80217 USA
Phone: 303-675-2175 or 800-344-3860 Toll Free USA/Canada
Fax: 303-675-2176 or 800-344-3867 Toll Free USA/Canada
Email: orderlit@onsemi.com

N. American Technical Support: 800-282-9855 Toll Free
USA/Canada
Europe, Middle East and Africa Technical Support:
Phone: 421 33 790 2910
Japan Customer Focus Center
Phone: 81-3-5773-3850

ON Semiconductor Website: www.onsemi.com
Order Literature: <http://www.onsemi.com/orderlit>
For additional information, please contact your local Sales Representative